

Χάντρωμα Φύλλου για Κλειδαριά IN LINE της GU  
Machining of Sash for IN LINE GU Lock

**TH 12204**

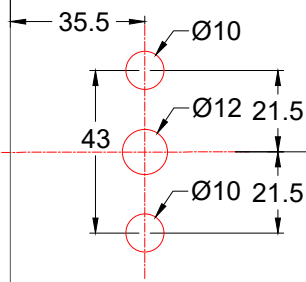

**SP 00987**

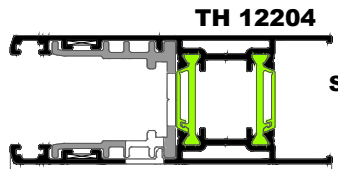
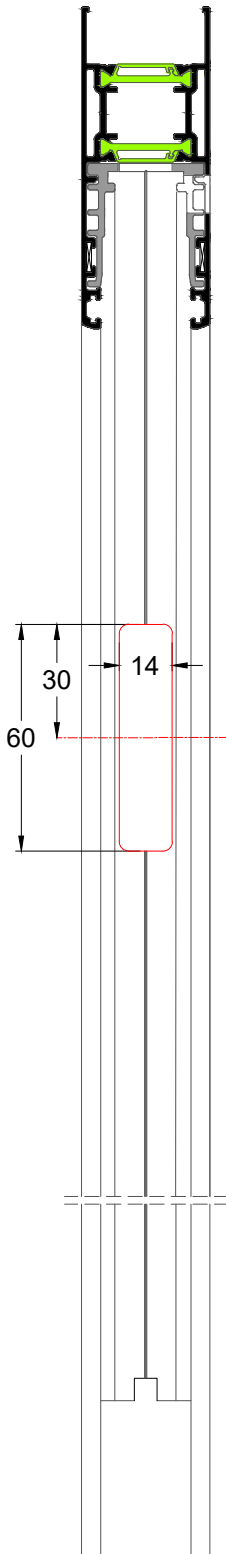
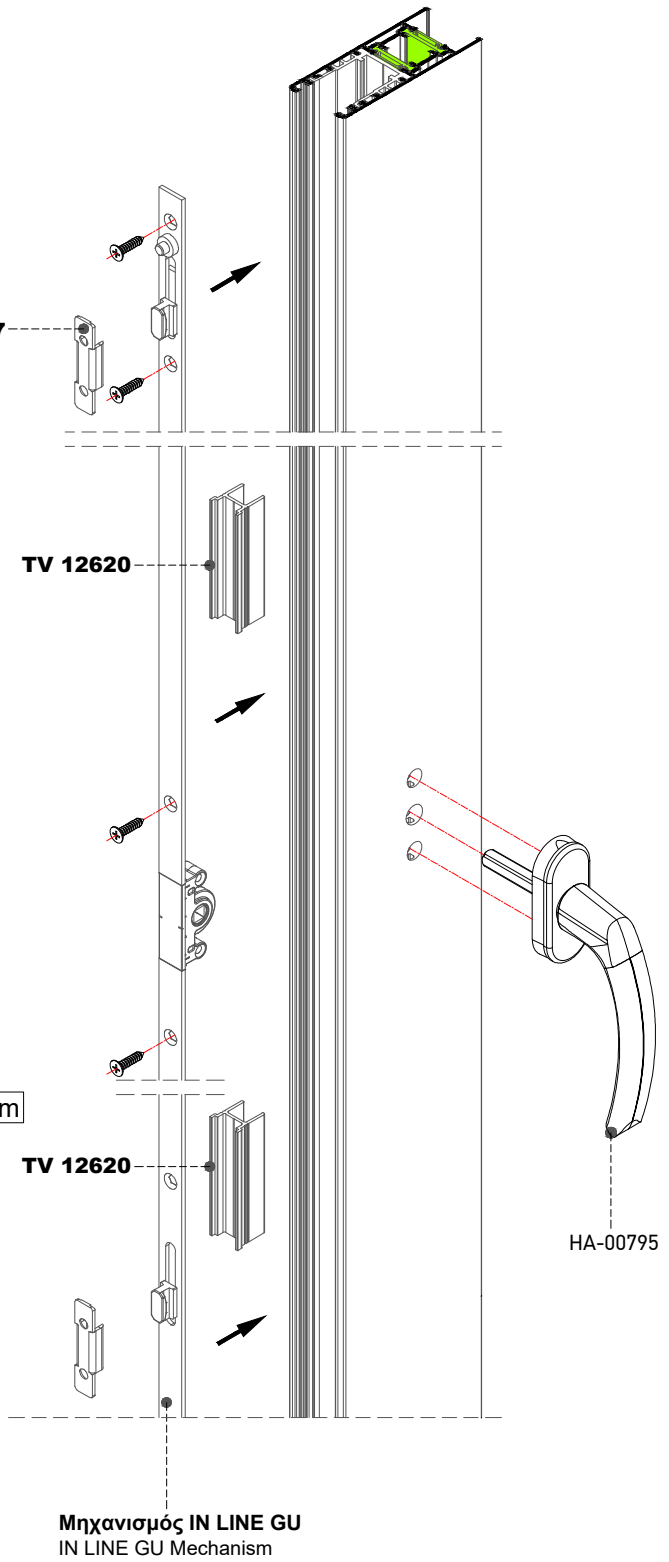

**Μηχανισμός IN LINE GU**  
IN LINE GU Mechanism

HA-00795

Μηχανισμός IN LINE GU  
IN LINE GU Locking Mechanism

**SP-00987**

(E-13880)

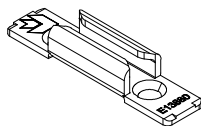

Αντίκρισμα Κλειδώματος GU  
Nest for Locking mechanism GU

**TV 12620**

Συσκευασία - Package

6 μέτρα-meter

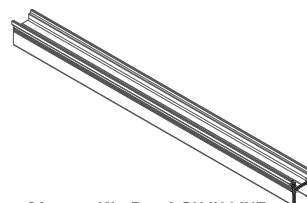

Προσθήκη για Κλειδαριά GU IN LINE  
Addition Profile for IN LINE GU

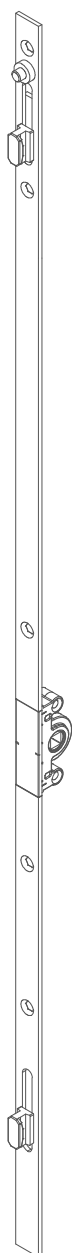

**IN LINE GU 90°**

<b>AU-SL-00980-09</b> <small>(G-13954-06-0-1)</small>	<b>L600,2 Κλειδώματα</b>
<b>AU-SL-00981-09</b> <small>(G-13954-10-0-1)</small>	<b>L1000,2 Κλειδώματα</b>
<b>AU-SL-00982-09</b> <small>(G-13954-26-0-1)</small>	<b>L1600,4 Κλειδώματα</b>

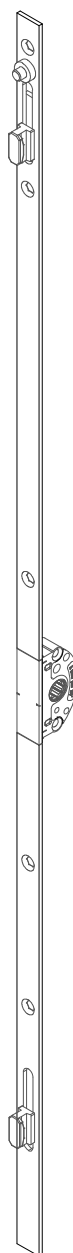
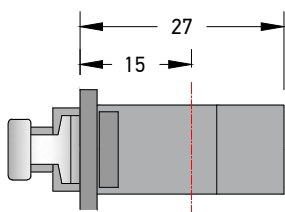

**IN LINE GU 180°**

<b>AU-SL-00980-09</b> <small>(G-25716-13-0-1)</small>	<b>L300,2 Κλειδώματα</b>
<b>AU-SL-00981-09</b> <small>(G-25716-06-0-1)</small>	<b>L600,2 Κλειδώματα</b>
<b>AU-SL-00982-09</b> <small>(G-25716-20-0-1)</small>	<b>L1000,3 Κλειδώματα</b>
<b>AU-SL-00982-09</b> <small>(G-25716-26-0-1)</small>	<b>L1600,4 Κλειδώματα</b>

